

AXOR Starck
Single-Hole Faucet 100 with Lever Handle and Pop-Up Drain, 1.2 GPM
 Finishes : **chrome** Part no. : **10001001**



Features

- Consists of: Pop-up assembly, Single-handle faucet
- Spray modes: Aerated spray
- Flow: 1.2 GPM (4.5 L/Min)
- Ceramic cartridge
- Includes pop-up drain

Item details

List Price \$ 550.00

Technology



Compliance

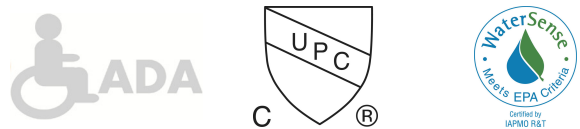

Product image



Scale drawing

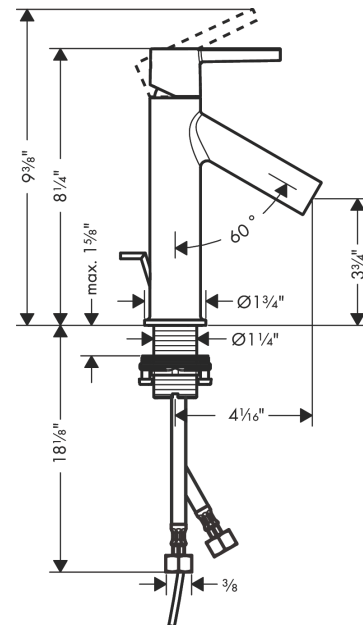

AXOR Starck
Single-Hole Faucet 100 with Lever Handle and Pop-Up Drain, 1.2 GPM
 Finishes : **chrome** Part no. : **10001001**



Exploded drawing

Year of production: >10/20

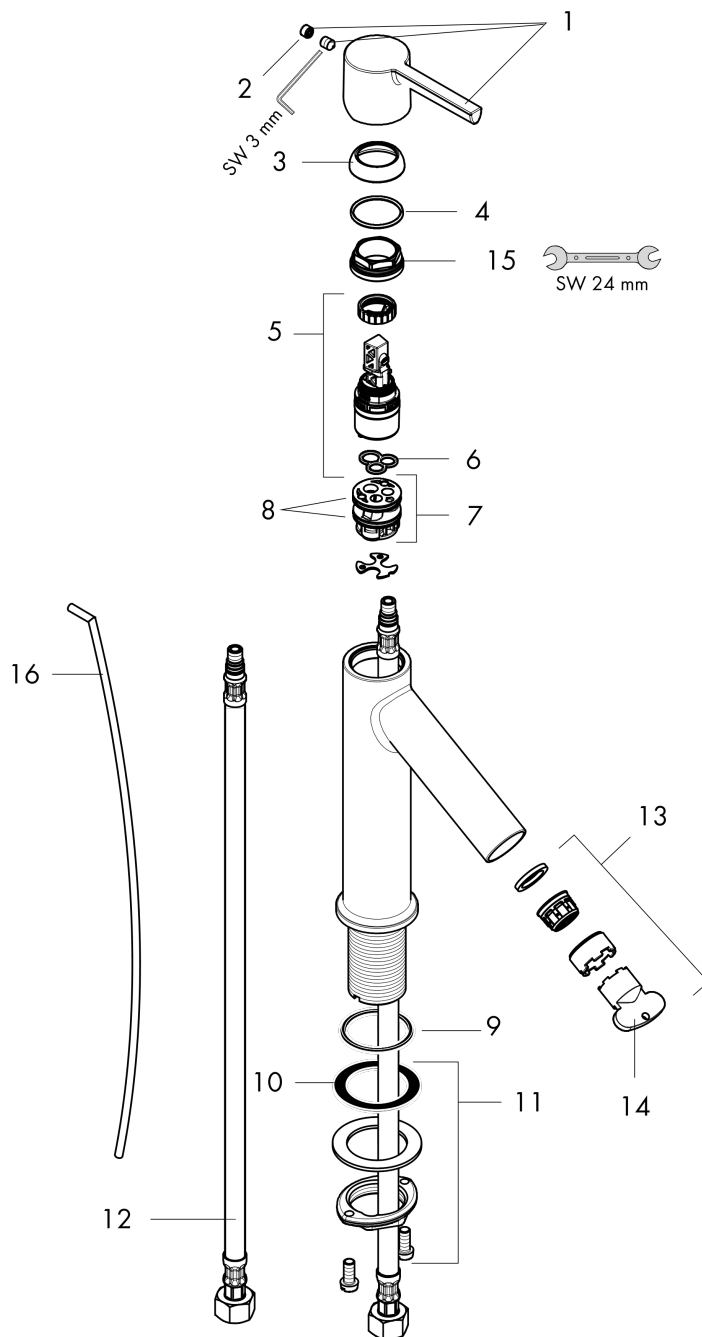

AXOR Starck
Single-Hole Faucet 100 with Lever Handle and Pop-Up Drain, 1.2 GPM
 Finishes : **chrome** Part no. : **10001001**



Spare parts list

Year of production: >10/20

Pos.		Part no.	Price	PU
1	handle	92385000	-	1
2	screw cover	96762000	-	1
3	flange	98863000	-	1
4	O-Ring 22x2	98185000	-	1
5	cartridge, assy	95973001	-	1
6	seal	98865000	-	1
7	adapter for cartridge	98866000	-	1
8	O-ring 23x2	98398000	-	1
9	O-ring 34x4	98155000	-	1
10	lever collar	97548000	-	1
11	fixing set (Ø 32)	13961000	-	1
12	connection hose 23½" M8x0,75 3/8"	98600001	-	1
13	aerator M24x1 (4,5 l/min)	92386001	-	1
14	special tool	95290000	-	1
15	nut	95178000	-	1
16	pull rod	97158000	-	1
a	pop up waste	88509000	-	1